

الجمهورية العربية السورية
وزارة التربية والتعليم

Grade six

English

Workbook

2025 - 2026

6



حقوق الطِّبَاعَةِ وَالتَّوْزِيعِ مَحْفُوظَةٌ لِلْمُؤَسَّسَةِ الْعَامَّةِ لِلطِّبَاعَةِ
حقوقُ التَّأْلِيفِ وَالنَّشْرِ مَحْفُوظَةٌ لوزارة التَّربِيَةِ وَالتَّعْلِيمِ
الجُمْهُورِيَّةُ الْعَرَبِيَّةُ السُّورِيَّةُ

Contents

Unit		Page
1	Countries	5
2	At the Theatre	9
3	The Big Blue	13
4	Arts	17
5	What's on TV	21
	Revision 1	25
6	At the Hospital	27
7	Free Time	31
8	Appearance	35
9	Farming	39
10	Recycling and Reusing	43
	Revision 2	47
11	Tasty Food	49
12	Shopping World	53
13	Feelings	57
14	Natural Resources	61
15	I Know my Rights	65
	Revision 3	69
16	Parties	71
17	Maths	75
18	Technology	79
19	Holidays	83
20	The Solar System	87
	Revision 4	91

1

Countries

1. Read the text and do the tasks below.

Citizenship

Citizenship means to be a good citizen in your community, following rules and helping people. Good citizens are kind and helpful people. It is not very difficult to be a good citizen. Ramez, for example, is a good citizen. He goes to school every day. Ramez likes to read about the world. He learns about the history of different countries and their cultures. This way, he can respect others and take care of things. Ramez is very nice to everyone. He also helps old people. At weekends, Ramez does some voluntary work with his friends to protect the environment. They pick up rubbish in parks and plant trees. We can all be good citizens. It feels great to make the world a better place.

a. Write true (T) or false (F).

1. It is difficult to be a good citizen.
2. We should learn about history and different cultures to respect others.
3. At weekends, Ramez plays video games with his friends.
4. When we pick up rubbish we help the environment.
5. Making the world a better place helps us feel great.

b. Read and fill in the spaces with these verbs.

protect be follow learn do

We should

1. good citizens.
2. some voluntary work in our community.
3. the rules and laws.
4. about the world around you.
5. the environment.

2. Read, match and write the nationality in the correct category in the chart.

1. England

a. Korean

2. Korea

b. Chinese

3. Italy

c. English

4. China

d. Italian

-ian	-an	-ese	-ish

3.  Listen and underline the word with the sound / ɪə /.

ear

bear

clear

appear

main

tear



4. Practice a similar conversation.

- Where are you from?
- What is your nationality?
- What language do you speak?

- I am from Egypt.
- I'm Egyptian.
- We speak Arabic.



5. Listen and choose.

The United Kingdom consists of (three / four) countries. Each country has its own (culture / flag) and capital, but they share the same (clothes / language) and money. The United Kingdom has a (flag / symbol) that combines all the four flags. These countries are England, Scotland, Wales and (Southern / Northern) Ireland.



6. Rewrite the sentences with pronouns.

- 1. Fiona read about the continents. e.g. She read about them.
- 2. Eve is carrying a map.
- 3. Peter is listening to Ms. Linda.
- 4. The teacher asked Hazem to talk about his country.
.....
- 5. Some students are telling my friends and me about their countries.

7. Read these sentences and match.

- 1. London is the capital city of England.
- 2. Australia is surrounded by water.
- 3. It is fun to visit different countries.
- 4. The official language in Syria is Arabic.
- 5. My country is very beautiful.

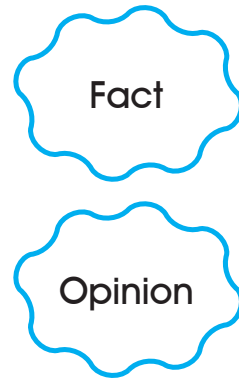

8. Write about your country or a country you would like to visit using facts and opinions.

.....

.....

.....

.....

.....

.....

2

At the Theatre

1. Read the text and do the tasks below.

The history of theatres goes back to the ancient times. Theatres have different kinds such as the puppet theatre, the shadow theatre, the carriage theatre and the modern theatre. Actors and actresses perform plays on the stage in order to entertain the audience and teach moral lessons.



In Syria, all kinds of theatres, the old and the modern ones, are active. Visitors all around the world come to Bosra Theatre or to Aleppo Castle theatre to watch and enjoy the beautiful dances, songs, plays and shows which are performed on those stages.

a. Write true (T) or false (F).

1. The history of theatres is new.
2. There are many types of theatres.
3. People come to Bosra to enjoy plays only.
4. There is a lesson in every play.
5. Syria doesn't have old theatres.



b. Match column (A) with column (B).

(A)

(B)

- | | |
|----------------------------------|--------------------------------|
| 1. Toys are used... | a. perform plays on the stage. |
| 2. All kinds of theatres... | b. learn a lesson. |
| 3. Syria has both... | c. old and new theatres. |
| 4. Actors and actresses... | d. are active in Syria. |
| 5. When you watch a play, you... | e. in the puppet theatre. |

2. Fill in the spaces with the words from the box.

open

start

watch

feel

get

make

When you want to ⁽¹⁾ a play in the theatre, you have to ⁽²⁾ a ticket first. The seat number is on your ticket. Then, you sit quietly until the curtains ⁽³⁾ After that, the actors and actresses ⁽⁴⁾ performing the play. They do their best to ⁽⁵⁾ the audience ⁽⁶⁾ happy with their performance.

3. Listen and write (a) or (ai).

l ---- te

s ---- l

t ----- l

r ---- ce

p ---- nt

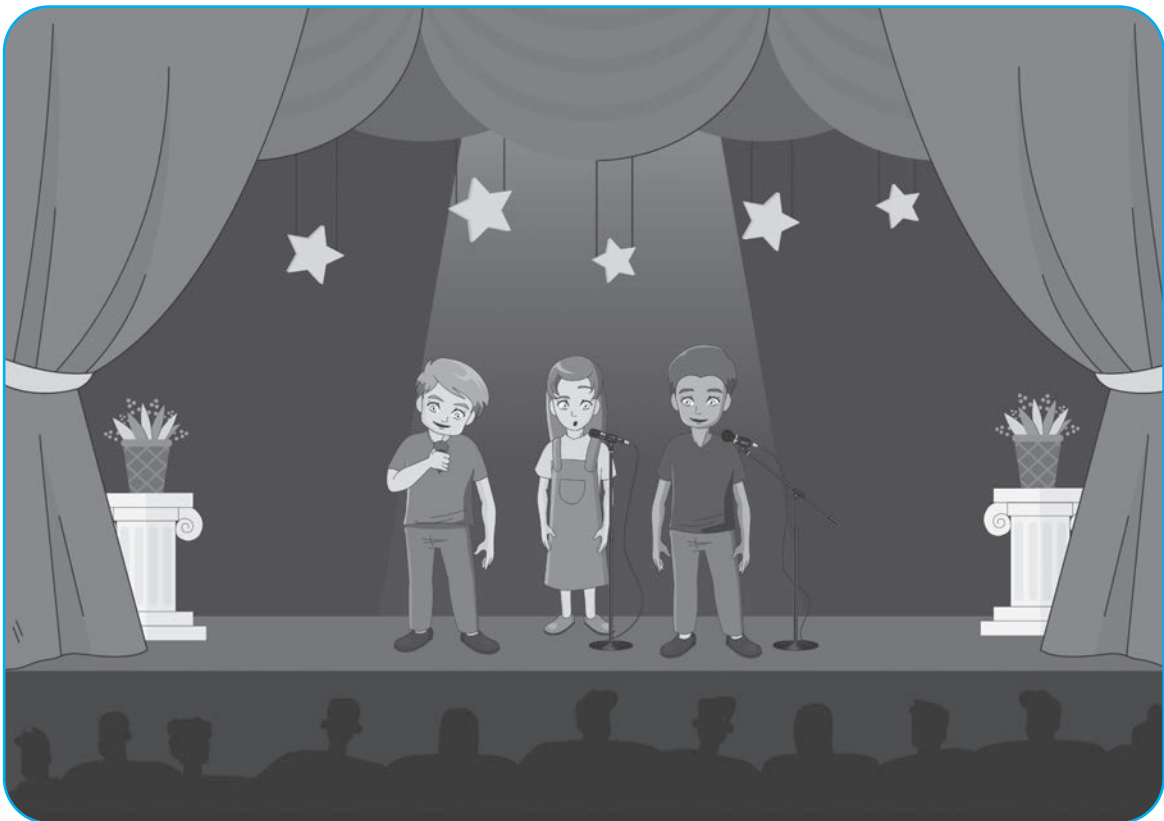

4.  Listen and number.

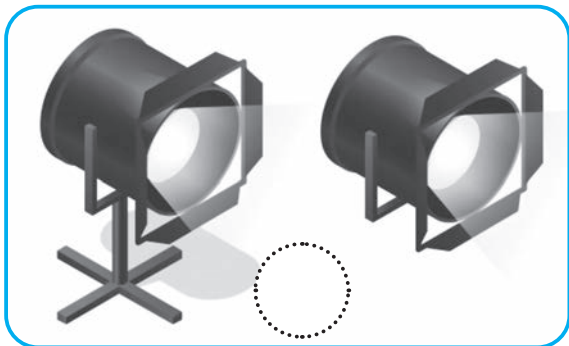
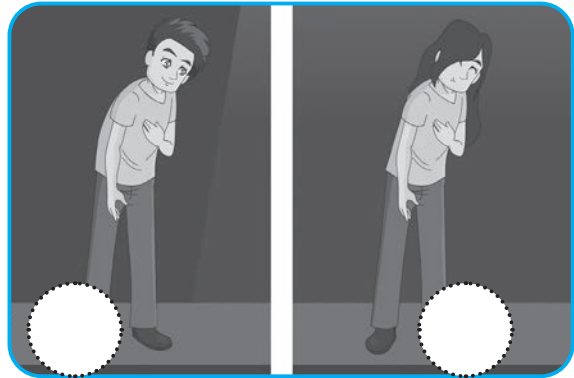

5. Practise with a partner.

My friend, Salem, and I went to the theatre yesterday.

Great! I like theatres, too.

Really? Who is your favourite actor?

His favourite actor is

My favourite actor is
What about Salem?

6. Choose the correct word.

1. Fatima and (her / hers) father are watching a play.
2. The people are enjoying (their / theirs) time.
3. Mona Wasef is (mine / my) favourite actress.
4. These tickets are (our / ours).
5. This is my seat and that is (yours / your).
6. The curtain on the stage is beautiful. (Its / It) colour is blue.

7. Rewrite using the correct punctuation.

1. dunia is my best friend
.....
2. where is your ticket please
.....
3. the actors and the actresses are wearing their costumes
.....

8. Write about a play you have seen.

My family and I went to the theatre

.....

.....

3

The Big Blue

1. Read the text and do the tasks below.

- are sea animals.
- have hard shells to protect them.
- Their shells are covered with scales.

Turtles

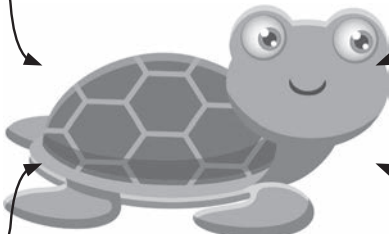

- can hold their breath for one hour.
- can lay eggs.
- are reptiles.

- Not all turtles can tuck their heads inside the shells.
- have webbed feet.

- can float.
- only come out of water to lay eggs.

a. Fill in the spaces with the correct words.

Turtles are amazing sea animals. They have hard (1) to protect them. Their shells are covered with (2) Not all turtles can (3) their head inside the shell. They can also (4) their (5) for one hour. Turtles are (6) They have (7) Turtles can (8) eggs. They can (9) in water. Turtles only come out of water to (10)

b. Fill in the columns with the right information about turtles.

Turtles		
are	have	can

2. Write the words (more than one answer is possible).

1. Sea mammals:
2. Sea animal with gills:
3. Sea animal that stings:
4. Sea animal that can change its colour:
.....

3.  Listen and unscramble these words.







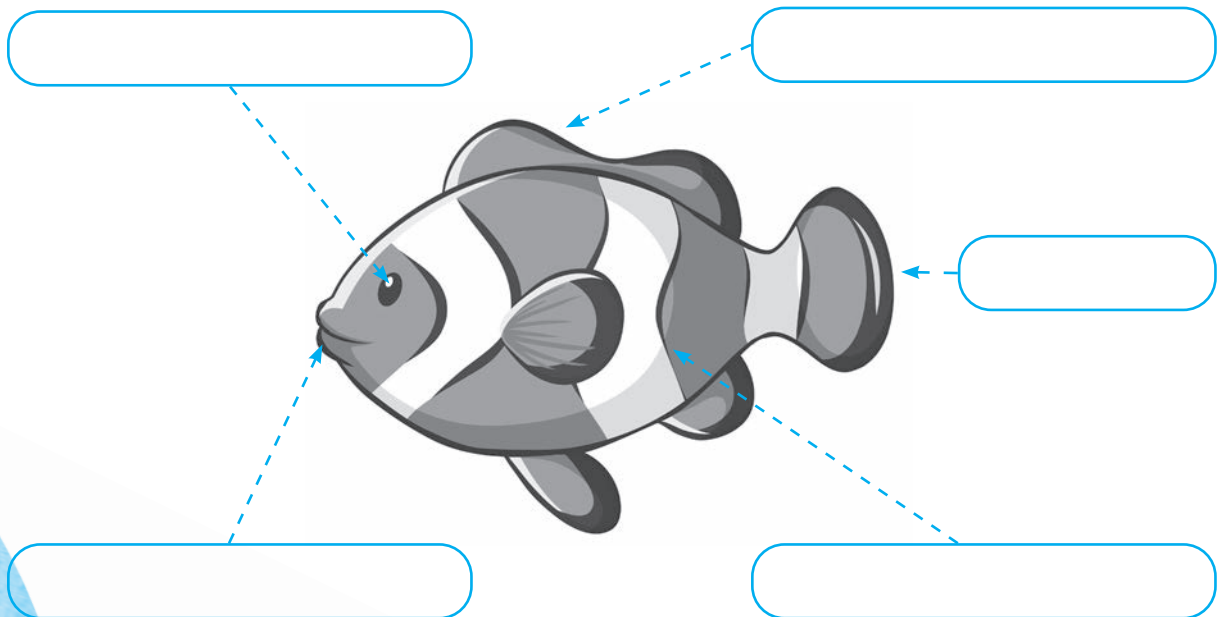

rwpeo		wreot	
ruoh		ruso	
oerhsw		lewrfo	

4. Fill in the spaces with these words.

eyes, tail, gills, fin, mouth



5. In pairs, ask your partner "Who am I?"

			
Whale	Octopus	Seahorse	Crab
			
Dolphin	Starfish	Shark	Turtle

Pupil A	Pupil B
1. I'm a small fish but I have the head of a horse. Who am I?	2. I'm very nice and intelligent, I have lungs not gills. Who am I?
3. I'm a big fish and have sharp teeth. Who am I?	4. I'm the biggest animal in the sea. Who am I?
5. I'm called a sea star. Who am I?	6. I have a small shell, and I walk sideways. Who am I?
7. My name means 8 feet. Who am I?	8. I have a big shell. I'm very slow and I live very long. Who am I?

6.  Listen and choose.

1. Seahorses have (fins / tails) to help them move.
2. They also swim (upright / right).
3. Seahorses have (curly tails / long noses).
4. They have no (teeth / mouth) and no stomach.
5. Seahorses feed on (tiny / small) sea animals.



7. Fill in the spaces using the present simple.

1. Sharks ----- all over the sea world. (live)
2. ----- they ----- with lungs? (breathe)
3. No, they ----- . (not)
4. The shark ----- with gills. (breathe)
5. It ----- too much as people think. (not eat)

8. Fill in the spaces with (It has- It is- Its)

1. The dolphin moves its tail up and down. -----
2. The turtle swims fast. It's got flipped feet. -----
3. The blue whale is very big. It's about 100 feet long. -----
4. I love the sea and its animals. -----
5. It's a big ocean. ----- .

9. Write about your favourite sea fish and animals, then draw them.

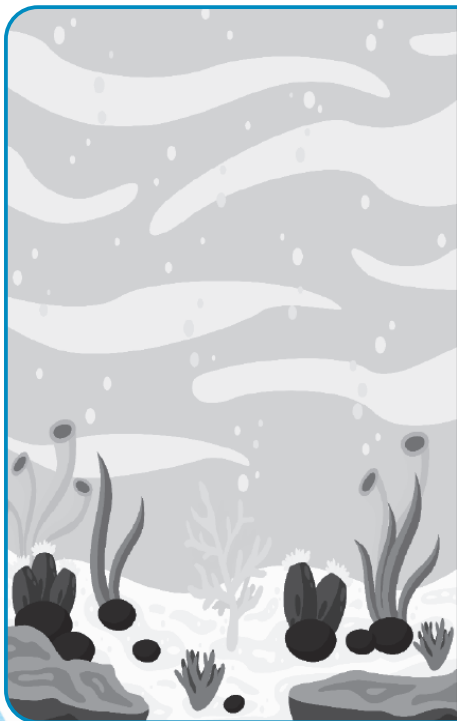

A large rectangular area with a blue border, containing ten horizontal dotted lines for writing.

4

Arts

1. Read the text and do the tasks below.

Tina: Wow! It's amazing here!

Lola: Yes, look. Is that Marta?

Tim: Ah! Yes, she's my favourite actress.

What is she doing?

Tina: She's talking to the director.

Tim: I think he wants her to repeat the scene.

Tina: What is she wearing?

Lola: She's wearing a strange suit.

Tim: Yes, the film is about space. The costumes must be strange.

Lola: The director is angry. He's shouting all the time. He isn't talking quietly.

Tina: The cameraman seems very busy.

He is moving the camera to another place.

Tim: And that man is fixing the lights.

Lola: There are lots of men building the set.

Tina: The actors are reading the script.

Tim: I am excited! I can't wait to see the film in the cinema.

a. Write true (T) or false (F).

1. The children are watching a film on TV.
2. Marta is their friend.
3. The cameraman is shouting all the time.
4. A man is fixing the lights.
5. A few men are building the set.

b. Match the words to their meanings.

- | | |
|------------|--|
| 1. costume | a. where the film takes place. |
| 2. actress | b. a written story. |
| 3. scene | c. a piece of action that happens in a film. |
| 4. script | d. clothes that actors wear. |
| 5. set | e. a woman who acts in a film. |

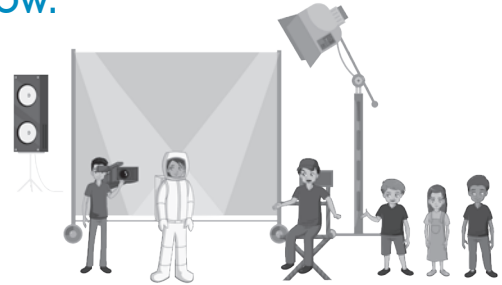

2. Match.

- | | |
|--|-----------------|
| 1. I see beautiful paintings in the | a. museum. |
| 2. I watch films in the | b. theatre. |
| 3. The audience are cheering the actors in the | c. art gallery. |
| 4. There are old objects from ancient times in the | d. cinema. |

3. Listen and choose the suitable word.

- | | |
|-------------|----------|
| 1. a. right | b. write |
| 2. a. see | b. sea |
| 3. a. see | b. sea |
| 4. a. peace | b. piece |

4. Write the words under the pictures.

architect

actor

sculptor

painter

writer



a.



b.



c.



d.



e.

5.  Listen and choose the correct answer.

1. In architecture, you buildings.

- a. make b. draw c. design

2. Costumes are used in

- a. architecture b. filming c. painting

3. In, you use metal and wood.

- a. painting b. sculpting c. filming

4. Colours and a palette help you in

- a. painting b. filming c. architecture

5. When you write words in a beautiful way, you're writing

- a. films b. stories c. plans

6. Look at the pictures and say what is happening there.

They are looking at the drawings.

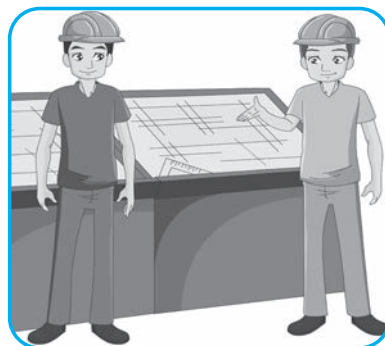
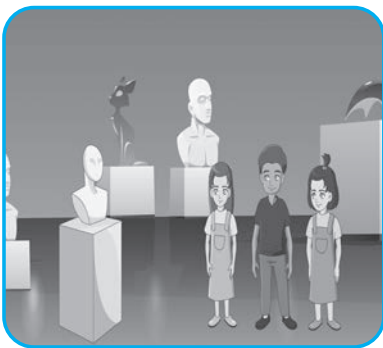

5

What's on TV?

1. Read the text and do the tasks below.

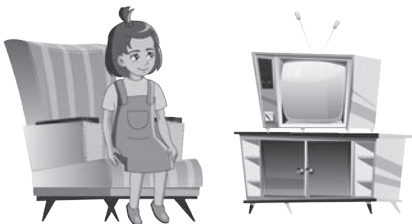

I'm Naya and I'm a student. I usually watch TV for an hour everyday after doing my homework. I only switch on the TV when I know there is something I want to watch and now I'm watching a new Disney film. I sometimes watch the news because I think

it's important to know what's happening in the world. I also like to watch documentaries, especially the ones about space and the natural world. However, I don't like many other programmes, like TV series. There are too many of them and nothing interesting ever happens. When they are on, I get the remote control and switch the TV off!

a. Choose a, b or c.

1. Naya watches TV

- a. all day long b. after doing homework c. every evening

2. She usually doesn't watch lots of programmes but now she's watching

- a. a film b. a cartoon c. a series

3. To know what's happening in the world, she watches the

- a. weather forecast b. documentaries c. news

4. When there's something uninteresting on, Naya

- a. switches on the TV b. Changes the channel c. switches the TV off

b. Find in the text words that are opposites of.

switch off \neq

uninteresting \neq

unimportant \neq

hate \neq

2. Match each TV programme with its definition.

- | | |
|---------------------|---|
| a. Weather forecast | 1. It's about animals, plants, space or different subjects. |
| b. Sports programme | 2. A story that is on, everyday or many times a week. |
| c. Game show | 3. To know how the weather will be like. |
| d. Documentary | 4. It's about different sports. |
| e. TV Series | 5. People play games and win money or prizes. |

3. Listen and divide each word into two syllables.

- | | | | |
|-----------|----------|----------|-----------|
| 1. police | 2. April | 3. paper | 4. open |
| 5. baby | 6. tiger | 7. quiet | 8. spider |

4. Circle the correct answer.

1. "I'm watching"! "Oh, so that's why you're laughing loudly!"
a. the news b. a comedy series c. a documentary
2. My father is making a about birds for a TV channel.
a. documentary b. series c. game show
3. My grandmother never misses any episode of her favourite
a. film b. sports programme c. series
4. "Who Wants to Be a Millionaire" is a kind of
a. music programmes b. quiz shows c. adverts
5. I love Tom and Jerry are my favourite.
a. cartoons b. weather forecasts c. films

5. Ask your partner about tonight's TV guide.

E.g. Q: What's on channel 2 at six o'clock?

A: The pink Panther.

Q: What kind of programme is it?

A: It's a cartoon.

Evening	Channel 1	Channel 2	Channel 3	Channel 4
6:00 – 6:30	Friends (series)	The pink panther (cartoon)	Yummy food (cookery show)	News Time (news)
6:30 – 7:00	Ben 10 (cartoon)	Sport time (sports programme)	Sea world (documentary)	The four seasons (weather forecast)
7:00 – 8:00	Who wants to be a millionaire? (quiz show)	Spiderman (film)	Arab's got talent (Talent show)	Music all around (music programme)

6. Listen and number.

..... Yes, you can watch that.

..... I have no homework today.

..... What about your homework?

..... What's on?

...1... Mum, can I watch TV?

..... " Toy Story " .

7. Fill in spaces with the correct form of the verbs.

1. Emma often a uniform, but at the moment she a tracksuit. (wear)
2. Her mum always to classic music, but she to pop music right now. (listen)
3. My father the newspaper now, but he usually books. (read)
4. I usually milk, but today I juice because it's hot. (drink)
5. We a film at the cinema every weekend, but today we a new one on TV. (watch)

8. Put the speech marks in the correct places.

1. I want chicken for dinner, says Sara.
2. That costs 200 pounds said the salesman.
3. What is $10 + 27$? asks Miss Bryan.
4. Molly says, I love to watch cartoons.

9. Write about what your family usually do, and what they are doing now.

.....

.....

.....

.....

.....

.....

.....

.....



Revision 1

1. Read, complete and draw.

My family is from: _____



Language(s) spoken



Our Flag



National dish

Name of dish: _____



Traditional Clothing

2. Match.

- | | |
|-------------------------------|-----------------------------------|
| 1. The cameraman is shooting | a. three colours together. |
| 2. The actor is reading | b. a five-star hotel. |
| 3. The artist is mixing | c. a documentary about the space. |
| 4. The architect is designing | d. a famous historical site. |
| 5. The tourists are visiting | e. a new series script. |

3. Fill in the spaces with these words.

arms- seahorses- mammals- groups- gills- fish

1. A shark breathes underwater using
2. Whales are the largest in the ocean.
3. An octopus has eight
4. There are over 20 thousand types of in the ocean.
5. like to swim in pairs, or two together.
6. Dolphins live in called pods.

4. Turn the underlined words into pronouns.

1. Kareem is my brother.
2. These books are very heavy. I can't carry these books.
3. Did you find my hat? I can't find my hat.
4. Our teachers are very helpful.
5. Sue is not at home. She went to visit her grandparents.

5. Read this TV guide then write what type of programmes they are.

11:00	Football in Syria	
11:30	The Pink Panther	
12:00	Robin Hood	
12:30	Snakes in the desert	
1:00	Voice kids	

6. Write the verbs in the present simple or continuous.

1. My brother loves painting and he often (paint) pictures ,but today he (paint) a portrait.
2. Ellen usually (design) theatre costumes. Today, she (act) in the play.
3. Right now, our teacher (give) us a test. He usually (give) us a test twice a month.
4. My mum (walk) with me to school every morning, but this morning my father (drive) me to school.
5. Bob sometimes (write) letters to his friends, but right now, he (write) an email to his cousin.

6

At the hospital

1. Read the text and do the tasks below.



Yesterday, Mrs. Brown was very ill. She had a fever. She phoned the doctor and made an appointment. When she arrived at the hospital, there were many patients. A man was suffering from backache. A woman had a sore throat and a little girl had a leg injury. The doctor called Mrs. Brown and examined her. He took her temperature.

He asked her some questions. She told him that she coughed, sneezed and had a runny nose. She had a headache. The doctor said she had flu and gave her the treatment: a syrup for the cough, tablets for the headache and injections. He advised her to stay in bed for three days.

a. What's the matter with Mrs. Brown?

Complete with words from the text.







b. Match the illnesses with the best advice.

1. a cough
2. a sore throat
3. a backache
4. a toothache
5. a cold
6. a broken arm
7. a cut
8. a fever

- a. Take some vitamin C
- b. Stay in bed and rest.
- c. Use an ice pack.
- d. Put a cast.
- e. Go to the dentist.
- f. Put a bandage.
- g. Drink lots of liquid.
- h. Take cough drops.

2. Write the correct number in front of each word.

				
1	2	3	4	5

Syringe

bandage

Heart beats

Thermometer

Oxygen
tank/ mask





First aid kit

Wheelchair









X ray

Pills

Cast

				
6	7	8	9	10

3.  Listen and write (oi – oy)

<p>t__ </p> <p>b__ </p>	<p>s__l </p> <p>p__nt </p>
<p>b__l </p> <p>c__n </p>	<p>j__ </p> <p>n__se </p>

4.  Listen and number the right pictures.

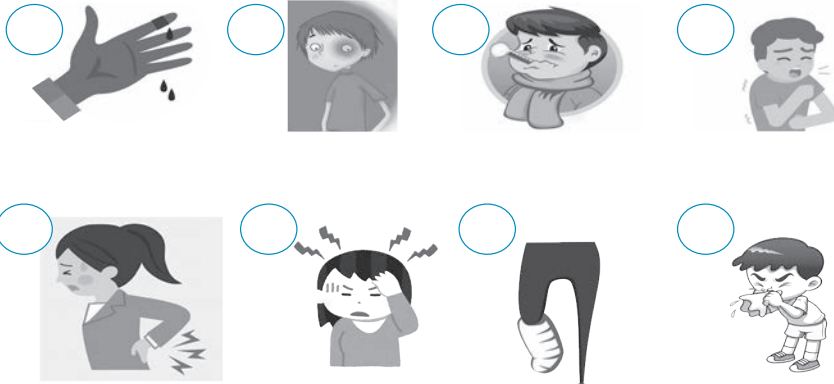

5. Tell your class what the health problems of these children were and help to find the treatment.

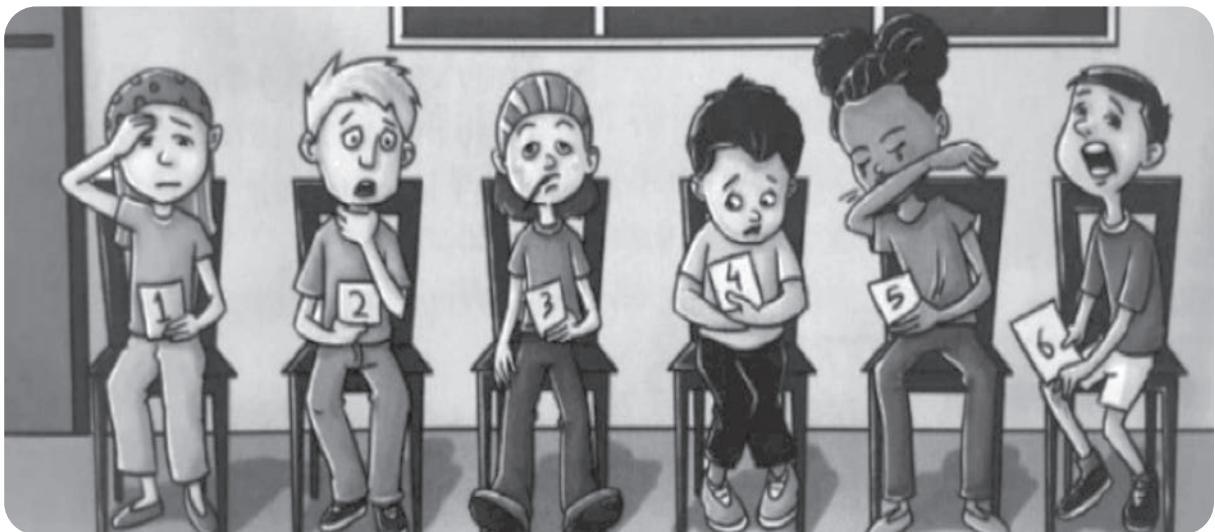

6. Look and write.

Mike went to the doctor yesterday.

Did Mike fall off a tree?

Did he twist his ankle?

What was the matter with Mike?

- 1.....
- 2.....
- 3.....
- 4.....



7. Write these sentences in the negative form.

- 1. She was ill last week.
- 2. He went to the doctor.
- 3. I cut my finger while cooking.

8. Write these sentences in the question form.

- 1. He had an injection.
- 2. I worked in a hospital.
- 3. She stayed in bed.

9. Rewrite the sentences correctly. Use capital letters where necessary.

- a. the national doctor's day is on 30th march .
.....
- b. my family and i have a medical checkup once a year.
.....
- c. our family doctor, mr. geller, gave my sister an injection.
.....
- d. hind travelled to france to have an operation.
.....

10. Write about a health problem happened to you.

.....

.....

.....

.....

.....

.....

.....

.....

7

Free Time

1. Read the dialogues and do the tasks below.

Rana: I'm really sorry, sir.

Teacher: Why are you so late, Rana?

Rana: I was stuck in a traffic jam.

Teacher: Next time please come earlier or you will miss the lesson.

Rana: Why don't we go to the concert tonight?

Helen: Sorry, it doesn't sound much fun to me. Let's go to the gym. It has been a long time since we worked out.

Rana: OK, that's a great idea.

Helen: How do you spend your free time?

Rana: I read adventure stories.

Helen: That's fine. Could you lend me some of them, please?

Rana: Yes, of course. I have various collections of stories.

a. Choose the correct answer.

1. Rana was late because of

- a. the traffic b. the rain c. the snow

2. Where did Rana and Helen decide to go?

- a. to the concert b. to the gym c. to the bookshop

3. What kind of books does Rana read in her spare time?

- a. history books b. poetry books c. story books

b. Write the underlined words in the text that match the meanings.

1. different types

2. couldn't get away from a place

3. exercised

2. Read and choose activities from the box.

What do they like doing in their free time?

1. Samar's got a lot of stories.
2. Lama looks for a lot of information on the websites
3. Ola's got a racing bike
4. Hassan likes growing and taking care of plants
5. Fayez got them from different countries

surfing the net	cycling	of
skiing	reading	of
collecting stamps	jogging	of
playing music	gardening	

3.  Listen and circle the words that are pronounced with (eə) like (where).

hair

swear

clear

dear

chair

4. Match.

- | | |
|--|---|
| <ol style="list-style-type: none"> 1. Can I change the channel, please? 2. I'm sorry. I broke the plate. 3. Can I talk to you for a moment? 4. Let's go to the restaurant. | <ol style="list-style-type: none"> a. Of course. what about? b. Sure, the remote control is on the table. c. Don't worry, I'll buy another one. d. Ok, it's a great idea. |
|--|---|

5.  Listen and write true (T) or false (F).

1. Mike likes climbing trees.
2. Mike is very busy these days.
3. Ryan spends his free time in the gym.
4. Ryan likes photography and gardening.

6. What would you say in the following situations.

1. Your friend wants to lose weight.



2. You are very hungry.
3. It's a beautiful day!
4. Your mum asked you to help her, but you got busy and forgot.
5. You have a new video game.
6. You were playing football and broke your neighbour's window.

7. Fill in the spaces with words from the list.

about don't Could let's what

- 1. read an adventure story.
- 2. How going to the theatre?
- 3. I have an orange juice, please?
- 4. Why you invite your friends?

8. Write the responses to the following situations.

- 1. Would you turn on the radio, please?
.....
- 2. I'm very sorry, I forgot my book at home.
.....
- 3. Let's go to the park. It's a nice day.
.....

9. Write the suggestions for the following situations.

- 1.
Yes, of course. I'll clean the dishes mum.
- 2.
Sorry, I can't go shopping now. I'm very busy.
- 3.
Don't worry, we'll water the plants later.

10. Write about what you like doing in your free time.

.....

.....

.....

.....

.....

.....

8

Appearance

1. Read the texts and do the tasks below.

1- Hi, I am I am a student. I am short and slim. I've got long wavy blonde hair and I have big blue eyes, I look like my mum. I have a lot of friends. I like to meet new people because I am out-going and funny.

2- Hi, I am I am a teacher. I am tall and slim. I've got short curly blonde hair and small green eyes. I like to read books. I always learn new things about my job. All my students love me because I am a hardworking and honest teacher.

3- She is She is a doctor. She is a medium-height plump girl. She's got long straight black hair and big black eyes. She looks like her father. She is kind and smart. She knows how to take care of her patients.

a. Write the names in the spaces.



Fayez



Linda



Janet

b. Match the questions with the right answers.

- | | |
|-------------------------------|---|
| 1. What does Linda look like? | a. He is hardworking and honest. |
| 2. What is Fayez like? | b. She looks like her father. |
| 3. Who does Janet look like? | c. She looks like her mum. |
| 4. What is Janet like? | d. She is a short slim girl. She's got long wavy blonde hair and big blue eyes. |
| 5. Who does Linda look like? | e. She is smart and kind. |

2. Fill in the spaces.

Short- slim-old-tall-long-short-plumb-young-curly-serious-straight-funny

1

2

3

4

5

6

3. Listen and classify the words in the table.

thing mother anything either thought there

θ			ð		
.....

4.  Listen and choose.

1. a. Tia is that tall smart plump girl.
b. Tia is that smart tall plump girl.
2. a. Tia has got blond long straight hair.
b. Tia has got long straight blond hair.
3. a. Mira is a slim medium-height beautiful girl.
b. Mira is a beautiful medium-height slim girl.
4. a. Mira has got short curly black hair.
b. Mira has got short black curly hair.

5. Ask and answer.

Think of someone in your class, let your friend guess who.



6. Read the sentences and classify the adjectives in the table.



	Opinion	Size	shape	age	colour
1					
2					
3					
4					

1. That is a nice old white house.
2. My friend gave me a beautiful big red bag.
3. I have a funny small white cat.
4. It's a beautiful big new car.

7. Write the adjectives in the right order.

1. My house is (new, big, nice)
2. This lady is (beautiful, slim, tall)
3. My cats are (fat, smart)
4. His grandmother (lovely, old, plumb)

8. Read the information in the table and write a similar paragraph about Miss Aisha and about you.

			your Photo
name	Mr.Ali	Miss.Aisha	
opinion	elegant	smart	
age	36	76	
height	tall	medium-height	
weight	slim	plump	
eyes	small/green	big/blue	
hair	brown	short/wavy/grey	

Mr. Ali is an elegant young man. He's tall and slim. He has got short brown hair with small green eyes.

Miss. Aisha is

.....

.....

.....

.....

.....

.....

My name is

.....

.....

.....

.....

.....

.....

9

Farming

1. Read the text and do the tasks below.

Plants are living things. Trees, flowers, grass and bushes are common plants. Plants make their own food from water, sunlight and soil. They reproduce with seeds. They have different parts: seeds, roots, stems, leaves, flowers and fruits. Most plants start as seeds. Seeds need a safe place to be buried in the soil before they can grow. The seed produces a plant. Some plants grow above the ground like tomatoes, aubergines and cabbage. Others have parts that grow under the ground like turnips, potatoes and beetroot. We use plants for food and drink. We also use them for medicines and making things like clothes.

a. Choose the correct answer.

1. Plants water, air and sunlight.

- a. can b. have c. need

2. Roots, and stems are parts of a plant.

- a. bushes b. leaves c. sunlight

3. Seeds must be put in the to reproduce.

- a. grass b. medicine c. soil

4. Turnips grow the ground.

- a. under b. between c. on

b. Fill in the spaces with.

to in on

1. plants' roots arethe soil.

2. The fruits are the tree.

3. The roots take water from the soil and give itthe leaves.

c. Label the picture.

root – stem – leaves - flower - fruit

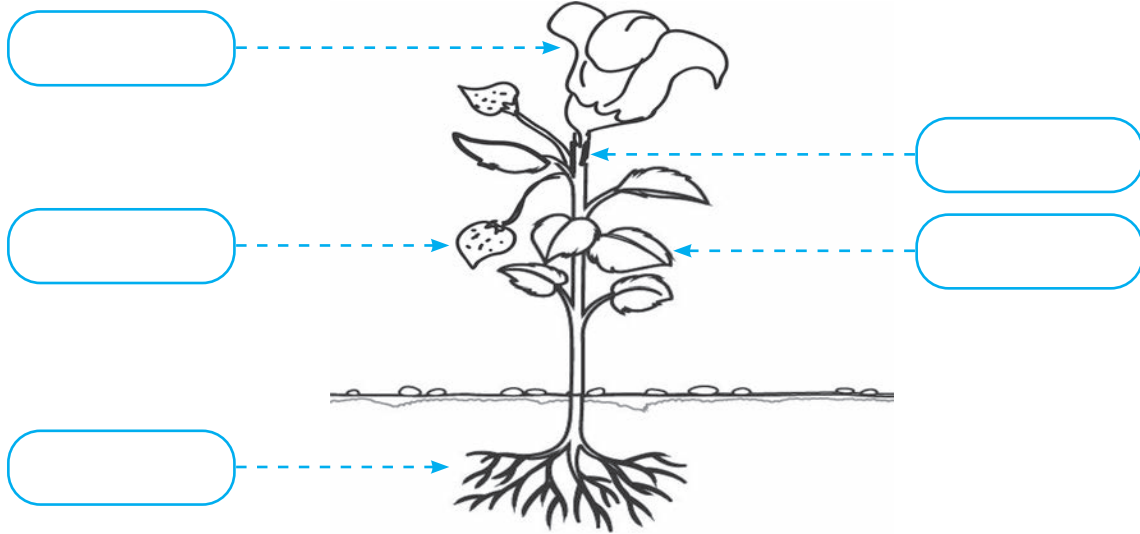

2. Write the words in the suitable column.

butterfly - ladybug - carrot - rabbit - potato - frog - turtle - flowers –
trees - ant - goldfish - orange – lettuce

animals	plants

3. Listen and choose the words you hear.

1. Maya lives in a small (town / house).
2. On the way, she heard a loud (sound / shout)
3. She looked back and (saw / found) her friend.
4. She was happy and said, “we can go (past / now)”.

4. Choose the best answer.

1. He went to the pond to catch some (sheep / fish).
2. He ate a whole (loaves / loaf) of bread.
3. (Geese / Calves) are baby cows.
4. She screamed when she saw a (mice / mouse).

5.  Listen and order.

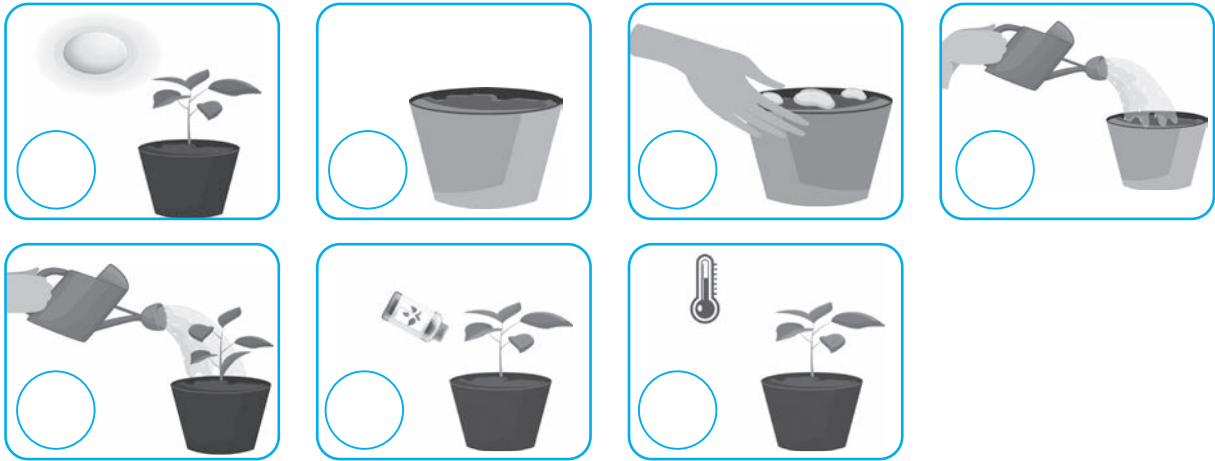

6.  Listen and choose the correct answer.

1. First, you put some (soil / plant) in the pot.
2. Second, you put the (water / seeds) in the pot.
3. Next, you push the seeds under the (sun / soil).
4. After that, you (put / water) the soil.
5. Put the pot in a (wet / sunny) place.

7. Practise a similar conversation.

What do plants need to grow?	They need
How do plants start?	They start as a
What are the parts of a plant?	They are.....
What do we use plants for?	We use them for.....
How do you grow a plant?	First,Then, you.....

8. Fill in the spaces with:

some any a the an

1. I haven't seen fruit trees in my uncle's garden.
2. My father planted fruit trees.
3. She watered trees.
4. She made salad with a cucumber, tomato and some mint.
5. He gave me orange to eat.

9. Look at the picture and write.



1. There are some fruit trees.
2. The farmer is
3. I can't see any
4.
5.

10. Describe a visit you have made to a farm.

.....

.....

.....

.....

10

Recycling and Reusing

1. Read the text and do the tasks below.



a planter for a flower



a rice container



a pencil case

Most of us want to help the environment today through many ways, and reusing is one of them. Instead of buying new things, we can reuse old ones. For example, we can reuse empty plastic bottles as planters for flowers, moneyboxes and pencil cases. Plastic and glass jars can be reused as containers for rice and sugar. We also can turn towels and cotton shirts into drying rags.

So, giving our children information about the importance of reusing can help to have a greener and healthier place.

a. Write true (T) or false (F).

1. Few people want to help the environment.
2. Reusing is bad for the environment.
3. We can't use old things again.
4. We should give our children information about recycling.

b. Match column "A" with column "B".

A

1. Reusing makes
2. Empty plastic bottles can
3. Plastic and glass jars can be
4. We can reuse cotton shirts

B

- a. as drying rags.
- b. the environment cleaner.
- c. be used as flower planters.
- d. turned into rice and sugar containers.

2.  Listen and choose the correct words.

1. flower - flour.
2. eight - ate.
3. flower - flour.
4. eight - ate.

3. Look at these pictures and describe each one.



4. Ask and answer.

Sara: What can we do with the old paper, Adam?

Adam:

Sara: Is it a good idea to

Adam: Yes / No, because

Sara: Well, we can also

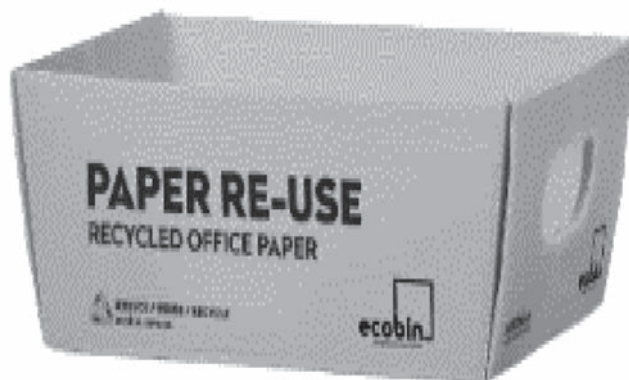

5.  Listen and choose the correct answer.

1. It's important to practise recycling (material / habit) at our schools.
2. Do you know that (50% / 80%) of what is used at school can be recycled?
3. Students can do (homework / projects) on recycling.
4. There should be a (competition / lesson) about recycling.

6. Choose the correct answer in brackets.

1. Recycling and reusing reduce (too much / too many) pollution.
2. Recycling doesn't need (much / many) energy.
3. I ate (much / many) sandwiches today.
4. There (is / are) too many people in the theatre.
5. There (is / are) too much traffic in this street.

7. Fill in the spaces with the correct punctuation.

As you know, recycling and reusing are great ways to save the natural resources Also they reduce the amount of waste
An important part of them is to keep the environment clean People should reduce the amount of waste they throw daily What do you think about this problem Sami

8. Write about some ways you know to keep the environment clean.

.....

.....

.....

.....

.....

.....

Revision 2

1. Find the mistakes in the following sentences and correct them.

1. I live on an farm.
2. There is a orange tree next to our house.
3. There isn't some water in the bucket.
4. My father milks the cows every morning.
5. There are any fish in the pond.
6. Is there some water in the bucket?

2. Read and choose a, b or c.

1. going to the cinema tonight?
a. Let's b. How about c. Would
2., I can't go to the gym.
a. I'm really sorry b. Can c. What about
3. go cycling.
a. Would b. Why don't c. Let's
4. you lend me your book, please?
a. Why don't you b. Would c. I'm terribly sorry
5. I drank coffee, I can't sleep.
a. too many b. too much c. many
6. There are boys in the playground.
a. much b. any c. many

3. Read, draw and colour.

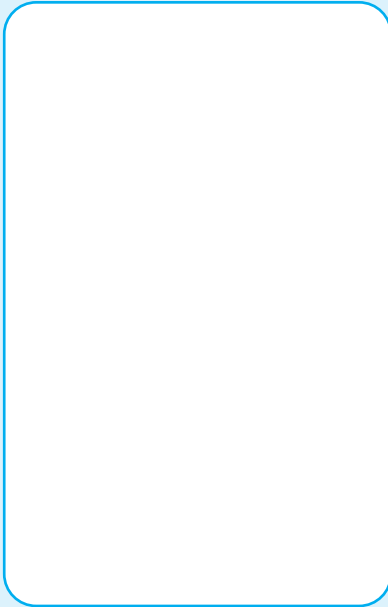

This is Katty. She is a pupil. Katty is short and slim. She has got short wavy blonde hair and big blue eyes. Katty is a funny girl.

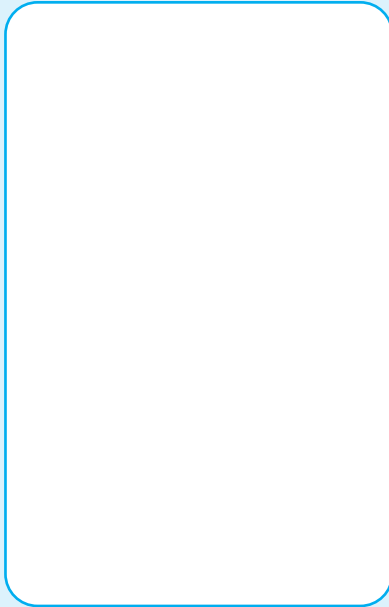

This is Radi. Radi is a doctor. He is tall and plumb. He has got short straight brown hair and small brown eyes. Radi is a serious man.

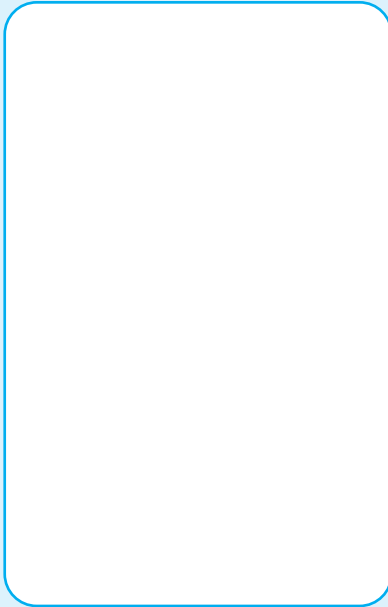

This is Hania. Hania is a teacher. She is a clever medium-height lady. She has got long straight black hair and big black eyes.

4. Find the words.

1. Bandage
2. Pills
3. Toothache
4. Cast
5. Treatment
6. Cough
7. Syringe

B	K	M	C	S	H	N	E	T
M	A	A	G	G	F	P	H	R
Z	S	N	U	G	I	I	C	E
T	C	O	D	P	A	L	A	A
O	C	H	U	A	C	L	H	T
H	V	B	X	D	G	S	T	M
E	Z	E	E	N	S	E	O	E
S	Y	R	I	N	G	E	O	N
X	D	X	B	Z	A	K	T	T

11

Tasty Food

1. Read and do the tasks below.



Hi. I'm Natali from Tartous. I want to tell you about what I have done recently.

I have visited the "Tropical Cave" by the Syrian coast. I've eaten the most delicious fruit ever. It was an amazing place. I went there with my family. We thought we were in the Amazon. There were all those strange-looking fruit, like the star fruit and the jackfruit.

In a restaurant there, we tried some of those fresh fruit. I tried the chocolate pudding fruit. It was a little bitter, but it really tasted like chocolate. Then we tried others, like the dragon fruit, which had a sweet taste, and the papaya, which was juicy just like mango.

Actually, it was a real adventure. I was really pleased.



a. Match the meanings with words from the text.

1. Full of juice.
2. With a taste like sugar.
3. Collected recently.
4. Not sweet.
5. Having a lovely taste.

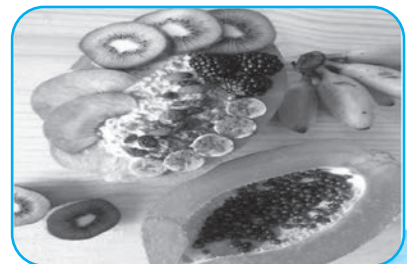

b. Choose a, b, or c.

1. The "Tropical Cave" is in

a. Arwad

b. Tartous

c. the Amazon

2. The has a juicy taste.

a. mango

b. star fruit

c. jackfruit

3. The dragon fruit is

a. sour

b. full of sugar

c. bitter

4. At the end Natali was

a. bored

b. scared

c. happy

2. Choose the correct verb and number the pictures.

1. I haven't (mixed / tasted) the sauce yet.

2. You've (peeled / sliced) the pepper.

3. She's (added / poured) some salt.

4. He hasn't (baked / kneaded) the dough yet.

5. Have you (grated / fried) the cheese yet?

6. Has she (chopped / boiled) the tomato yet?

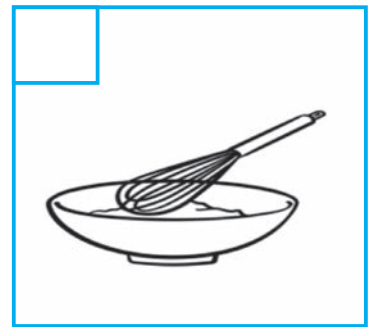
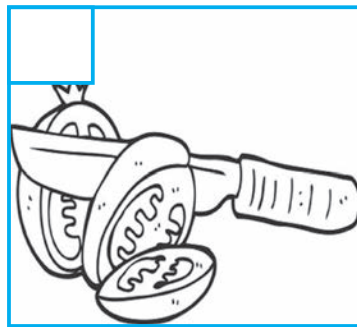
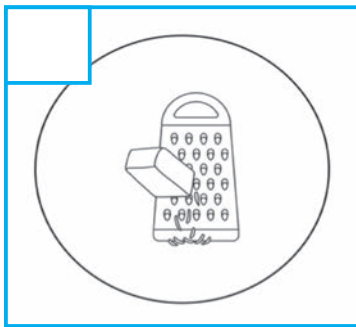

3.  Listen and write (g) or (ng).

1. wro__

2. si__er

3. ba__

4. ri__

5. __oal

4.  Listen to the dialogue then decide who says each sentence.

Write Matt or George.

1. We have finished most of the work.

2. I've tidied our room.

3. Have you washed the car yet?

4. I've helped mum.

5. Has she baked the cake yet?

6. Mum has just cooked the dinner.

7. They have arrived.

5. Look and say what Carla has/hasn't done.

Carla's to do list

- 1. prepare breakfast ✓
- 2. boil the eggs ✗
- 3. clean the table ✗
- 4. fry the potatoes ✓
- 5. _____
- 6. _____

She has...
She hasn't ...

6. Look and match the questions and answers.

	help with dinner	wash fruit	mix the cake	dry the dishes
Suma	✓	✗	✓	✗
Adam	✓	✓	✗	✗

1. Has Suma washed the fruit? a. Yes, she has.
2. Has Suma mixed the cake? b. No, he hasn't.
3. Has Adam washed the fruit? c. Yes, they have.
4. Has Adam mixed the cake? d. No, they haven't
5. Have Suma and Adam helped with dinner? e. No, she hasn't
6. Have Suma and Adam dried the dishes? f. Yes, he has.

7. Write full sentences using present perfect.

1. Salma/ just/ wash/ the dishes.
2. We/ not/ visit/ grandmother/ yet.
3. What/ you/ cook/ for lunch/ today?
4. he/ checked/ his email/ yet?
5. you/ grated/ the cheese/ yet?

8. Write what you have done to help your mum.

Today is a busy day. We have a big feast. I have to Make the salad and prepare the juice. I have finished most of the work. I have

- wash vegetables ✓
- chop cucumber ✗
- chop tomatoes
- slice lemon
- peel the onion
- grate carrot
- squeeze orange
- add sugar
- pour the juice in the glasses

.....

.....

.....

.....

.....

.....

.....

.....

.....

.....

12

Shopping Around the World

1. Read then do the tasks below.

Hello, I'm Nabil. I have never bought anything online. I really like going round the markets with my friends. There is a market every Friday near my house.



The market contains different parts. You can do your weekly grocery shopping from the food area where my parents always go. There is also the clothes section, which my sister loves. Actually, you can find everything in this market: books, furniture, glasses and many amazing goods. I have found an old paperweight there. It's made of heavy glass and it's wonderful because you can see different colours in it. I think it is an antique.

a. match the underlined words from the text with the definitions below.

1. An object we use to stop paper from blowing away.
2. Things that we sell and buy.
3. An old valuable thing.
4. Large objects such as chairs, tables, beds etc.
5. Food and other things that you can buy from the supermarket.

b. Choose a, b or c.

1. Nabil likes shopping.
a. online b. going c. grocery
2. Nabil goes to the market on
a. Friday b. Sunday c. Tuesday
3. Nabil's sister loves the part.
a. clothes b. food c. book
5. Nabil has bought an old
a. jacket b. furniture c. paperweight

2. Complete the table.

present	past	past participle
go	gone/been
do	did
have - has	had
get	got
buy	bought
take	took
eat	eaten
ride	rode
see
win	won

3. Listen and circle the /ɪə/ sound.

tears - hair - hear - square - engineer

4.  You are going to hear about one of the special times for shopping in another country. It is Dubai Shopping Festival. Listen and choose.

1. Dubai is a city in:
 - a. the United Arab Emirates
 - b. the United States of America.
2. During the festival the shops
 - a. sell online.
 - b. offer discounts.
3. There are a lot of:
 - a. handmade shops.
 - b. fashion shows.
4. He has stayed in Dubai:
 - a. for 14 days.
 - b. since 2016.



5. Look at Sandra's experiences and talk about it.

Sandra's experiences

1. go to a festival. ✓
2. win a prize. ✗
3. eat Chinese food since. ✗
4. see a fashion show many times. ✓
5. do online shopping. ✗
6. join English courses for 3 years. ✓

Sandra has been
to a festival

Sandra has never done
online shopping

6. Choose the correct answer.

- 1. I have had this lovely money box for (2 weeks / last week).
- 2. Malak has (ever / never) ridden a horse.
- 3. Steve isn't here. He has (been / gone) home.
- 4. We have (been / gone) to the new mall many times.
- 5. I haven't seen my uncle (for/ since) 2016.

7. Look at the picture and write.



5 years old

1. How long have you had your bike? (bike)

I have had my bike since I was 5 years old.



two years

2.? (prize)

.....



last month

3.? (sunglasses)

.....

8. Write about your shopping habits.

Where do you go shopping?

How often do you go shopping?

Do you go shopping in markets or online?

Have you bought any new things?

How long have you had them?

.....

.....

.....

1. Read the following text and do the tasks below.

Usually, surprises give happiness and pleasure. Last week, we planned a surprise reunion for my mother, Nadia. We sent an invitation to her close old friend, who lived in France, to spend the weekend at my grandparents' villa. In the afternoon, we went to our grandparents' villa.

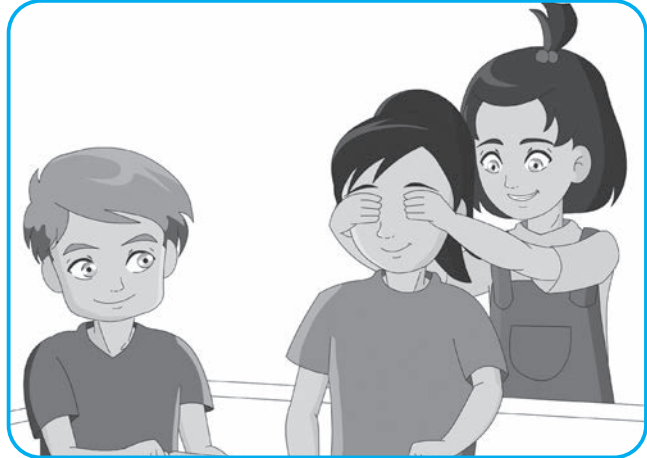

There, my mum was surprised when she saw her old friend, Maria, who came from France. Maria was impressed and pleased to have such an exciting meeting. My mum was very excited and proud of us. We had a lovely weekend.

a. Write True (T) or False (F).

1. Nadia was surprised in a positive way.
2. The reunion party was in their grandparents' villa.
3. Maria was sad to meet her best friend again.
4. They spent an unhappy weekend.
5. Their mother felt embarrassed to meet her friend.

b. Choose the correct adjectives in brackets.

1. Surprises make us feel (happy / unhappy)
2. Mum was (surprised / sad) when she saw her old friend.
3. Maria felt (worried / impressed) for having such an exciting meeting.
4. The weekend was (excited / lovely).

2. Fill in the spaces.

unhappy

tired

worried

pleased

hungry

1. I'm with my job, so I'm looking for a new one.
2. Mark has got good grades in his exam, so Mark is
3. Where were you? I was that something bad happened.
4. Lina has walked all day, so she's very
5. Nizar wants to eat because he is

3. Listen and circle the words with the sound / ʒ /.

1. division

2. joke

3. vision

4. judge

5. bandage

6. casual

7. measure

8. jug



4.  Listen and circle how each one is feeling.

- | | | |
|--------------------|--------------|-----------------|
| 1. a. angry | b. happy | c. careless |
| 2. a. excited | b. unhappy | c. confused |
| 3. a. careless | b. confident | c. embarrassed |
| 4. a. uninterested | b. worried | c. disappointed |

5. Ask and answer.

1. I feel happy when I see my friends. What about you?

1.
.....

2. When I am sad, I stay at home. What about you?

2.
.....

3. I felt embarrassed when I fell off my bike. What about you?

3.
.....

14

Natural Resources

1. Read the text and do the tasks below.



The world uses too much oil, gas and coal. These natural resources will not last for a long time. So, we must look for other sources like: solar power, wind power, and wave power. The solar power comes from the Sun which is the main source of energy for all living things. We

should use the sunlight to change it into useful forms of energy such as electricity. This is one way to protect the natural resources.

The Sun power doesn't cause pollution, and we can use it again and again.

a. Choose a, b or c.

1. The Sun gives us power.

- a. wind b. solar c. wave

2. Coal, oil and gas will not forever.

- a. finish b. work c. continue

3. The Sun is the main source of for all living things

- a. food b. water c. power

4. We can use the solar power.....

- a. many times b. twice c. once

b. Write true (T) or false (F).

1. The world uses only small amounts of natural resources.

2. The source of solar power is the Moon.

3. There is no need to look for other energy sources.

4. Solar energy is bad for the environment.

2. Look at these pictures and describe them.

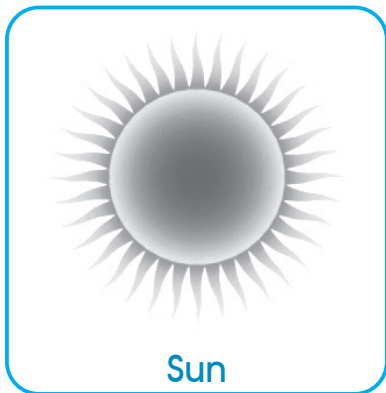

3. Ask your partner.

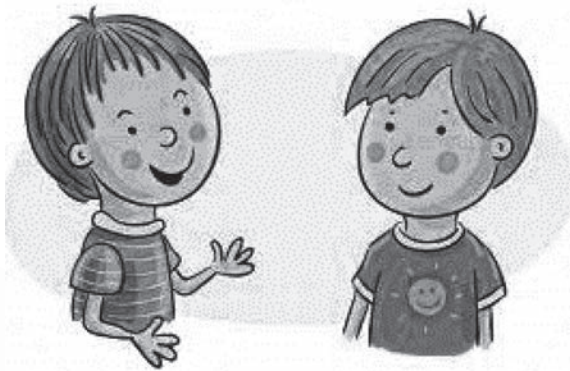

Rami: What kind of natural resources do you know?

Naser:

Rami: Do you think that people can use these resources for a long time?

Naser:

Rami: What should people do?

Naser:

4.  Listen and write the words that have the sound of aʊ or ɔɪ in the chart.

about boil now loud toy voice

aʊ	ɔɪ
1-	1-
2-	2-
3-	3-

5.  a. Listen and decide if the sentences are true or false.

1. The Sun and fire are some of the natural resources.
2. The Sun is the planet that gives heat to the Earth.
3. Oxygen is the only gas in the air.
4. Most of the Earth's surface is covered with water.

 b. Listen again and choose the correct answer between brackets.

1. The Sun is a (star / planet).
2. Plants use energy from the (soil / sunlight) to make their food.
3. Air has many (parts / gases).
4. Without the Sun, it is impossible to (live / stay).

15

I Know my Rights

1. Read the text and do the tasks below.



The United Nations listed the child's rights on the 20th November 1989 and this date is now the World Children's Day. It is a day to celebrate children because they are important in society. Every year on this day, teachers and parents around the world give ideas for children to learn about their rights and celebrate them. They do activities that are fun, practical and easy. They celebrate every year to ask for a better future for every child.

a. Write true (T) or false (F).

1. The United Nations made a list for children's rights in 1998.
2. Children have a day because they are important.
3. Parents are not a part of the celebration.
4. The world celebrates Children's Day to ask for a better future.

b. Choose a, b, or c.

1. We celebrate the World Children's Day on the
a. 12th December b. 2nd October c. 20th November
2. Teachers and parents around the world give ideas for children to
a. learn about their rights b. get money c. work
3. The activities which children do on the World Children's Day are
a. difficult b. boring c. fun

2. Read and tick the right column.

	Rights	Things we want
go to school		
have a pet		
watch TV		
have a house		
go on holiday		
be safe		

3. Listen and circle the silent letter.

wednesday muscle island sign biscuit walk writing

4. Find the words in the puzzle.

food

house

name

health

school

play

family

h	e	a	l	t	h	o
o	v	b	n	h	s	p
u	s	c	h	o	o	l
s	l	n	x	u	j	a
e	f	a	m	i	l	y
y	o	m	v	z	c	b
l	o	e	q	a	h	f
q	d	m	n	s	i	k

5.  Listen and tick the right they don't have.

	play and rest	be safe and healthy	learn and grow	mustn't work
Lamita				
Dani				
Amara				

6. Look at the pictures and talk about the child's rights you see.



7. Match A with B to make sentences.

A

1. Children can do activities
2. Nara wanted to play
3. Do you live in a house
4. I'd like to eat this pie

B

- a. but I am allergic to nuts.
- b. and learn about their rights.
- c. so she finished her homework early
- d. or a flat?

8. Write sentences about yourself.

1. On holiday, I often go or
2. I want to learn new things, so
3. I am young but
4. I need and

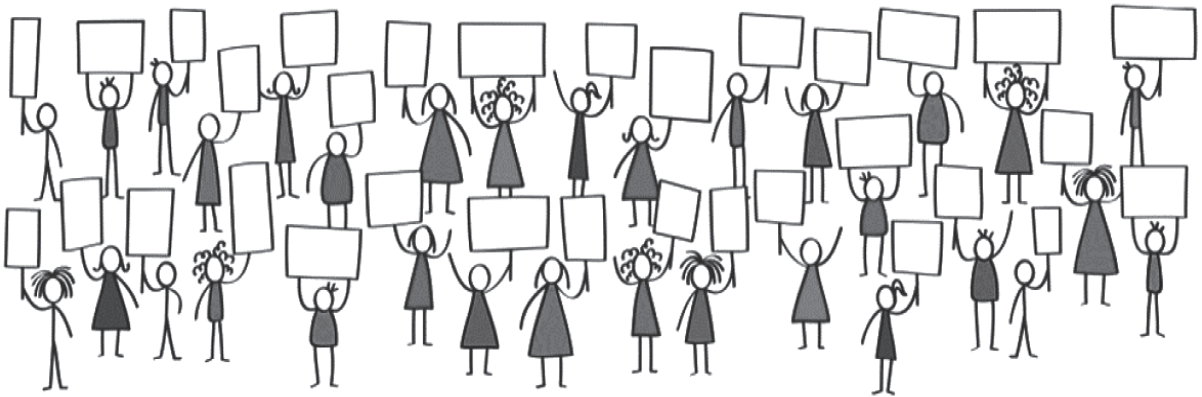

9. Write about children's rights.

.....

.....

.....

.....

.....

.....

.....

.....

.....

.....

Revision 3

1. Look at the pictures and write sentences using must, have to or should.

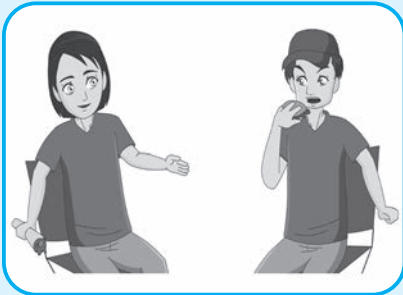





2. Choose the correct word in brackets.

1. She went shopping, (but / so) she didn't buy anything.
2. She planted trees, (but / so) she helped the environment.
3. She mixed the cake, (or / and) she put it in the oven.
4. Are you going right (but / or) left?

3. Write in the table.

have a name bitter forests confident soil sour
 be healthy scared happiness oil sweet learn and grow

right	feeling	taste	resource

4. Complete the sentences with a feeling from the list.

uninterested - scared - confident - happy

1. I have tidied the house. I feel



2. She has known her rights. She is



3. He doesn't want to play the piano. He is
in that.



4. We have watched a horror film. We are
.....



5. Complete with the suitable suffix or prefix.

dis un ness less

1. Sami wasappointed after his team lost the match.

2. She was filled with happi..... when she saw her friend.

3. He didn't practise well for the competition. He wasconfident
about the result.

4. He was driving in a care..... way. He was driving very fast.

6. Complete with these verbs. (use the present perfect)

go ride buy recycle eat

1. I my bag from the nearby market.

2. she ever a bike?

3. Tia three sandwiches since the morning.

4. He shopping.

5. Amer paper and cardboard to protect forests.

16

Parties

1. Read the text and do the tasks below.

One of my best occasions is Mother's Day. Last March, we celebrated it at a restaurant and invited all our relatives.

Each one of us had something to do. My sister chose the cake and the sweets. My brother bought the present. My dad booked tables at the restaurant.

On the day of the party, when we arrived at the restaurant, the restaurant staff were decorating the place with balloons and hanging lights. It was a surprise for my mum. We were clapping and singing when the waitress came with a huge cake.

We were cheering while my mum was cutting the cake, then we ate the cake and had a good time. It was delicious. It was the most enjoyable party I've ever had. My mom was so happy. We gave her the present and said "Happy Mother's Day".

a. Write true (T) or false (F).

1. They had the party in a coffee shop.
2. The cake was very big.
3. They didn't like the cake.
4. My sister came with a huge cake.

b. Answer the following questions.

1. What was the occasion?.....
2. When was the party?.....
3. Who did they invite to the party?.....
4. What were they doing while mum was cutting the cake?

.....

2. Match the questions to the answers.

1. What were you doing when it rained?	a. They went to the party by bus yesterday.
2. How did they go to the party yesterday?	b. He was going to the pharmacy when he met his friend.
3. Where was he going when he met his friend?	c. She was studying while her dad was sleeping.
4. What was she doing while her dad was sleeping?	d. I was having dinner when it rained.

3. Listen and circle the words that are pronounced like (nurse).

third

pride

stir

turn

4. Choose the correct answer in brackets.

1. My brother and I (was decorating / were decorating) the house last night.
2. I was cutting the cake while my friends were (singing / sang).
3. (Were / Was) your mother making your favourite dish?
4. (Were / Did) they write invitation cards yesterday?

5. Describe what they were doing yesterday evening.



6.  Listen and choose.

1. John had to go to his
a. grandpa's house b. uncle's house c. uncle's cottage
2. They decorated the sitting room with
a. balloons and flowers b. balloons and lights c. flowers and candles
3. received the guests.
a. Sandra's parents b. Sandra's brother c. Sandra's uncle
4. Sandra's was taking a photograph.
a. father b. cousin c. uncle

7. Write the words in the correct order.

1. having/yesterday/They/lunch/were/afternoon

..... ?

2. yesterday/Reem/lighting/was/the candles/evening

..... ?

3. doing /What/your mum/was/evening /yesterday

..... ?

8. Complete the following sentences.

1. While she was decorating the house,

2. They were celebrating when

3. What were you doing when

4. My brother and I were playing

9. Describe what happened at a party you were invited to.

.....

.....

.....

.....

.....

.....

.....

.....

.....

.....

1. Figure me out.

My age is the product of multiplying thirteen by three.

The number of sports games I've been to is the product of multiplying two by two.

You can know how tall I am by adding one hundred to seventy-one.

The number of pets I have is adding three plus one.



My birth month is the result of dividing seventy-seven by seven.

My birthday is when you divide forty-six by two.

The number of people in my family is multiplying two by three.

The number of sisters I have is the difference of subtracting one from four.

1. How old is Tia?
2. Which month was she born in?
3. When is her birthday?
4. How many sisters does she have?
5. How many pets does she have?
6. How tall is she?
7. What is the number of sports games she's been to?

2. Match.



- 1.minus 2.equal 3.divided by 4.multiplied by 5. plus

3. Finish the hopscotch game by filling in the missing number then say it.

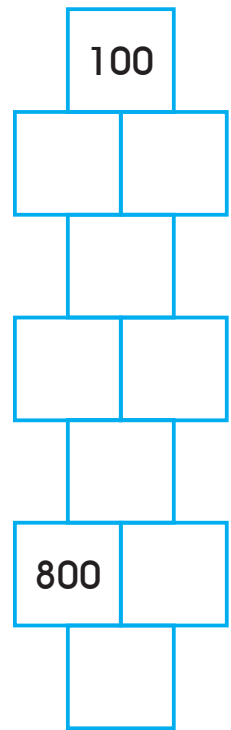
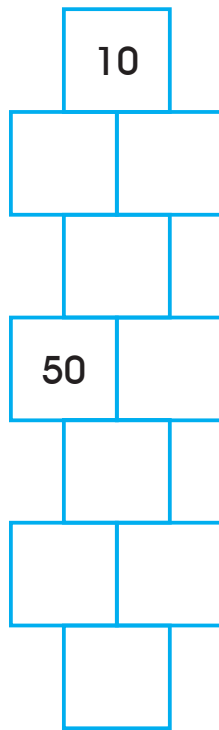
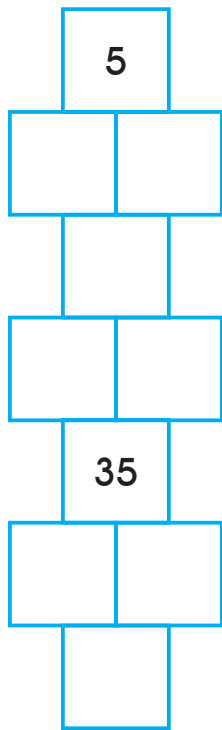

4.  Listen and classify.

August phone grow law sauce float

ɔ:			əʊ		

5. Read and do a similar conversation.

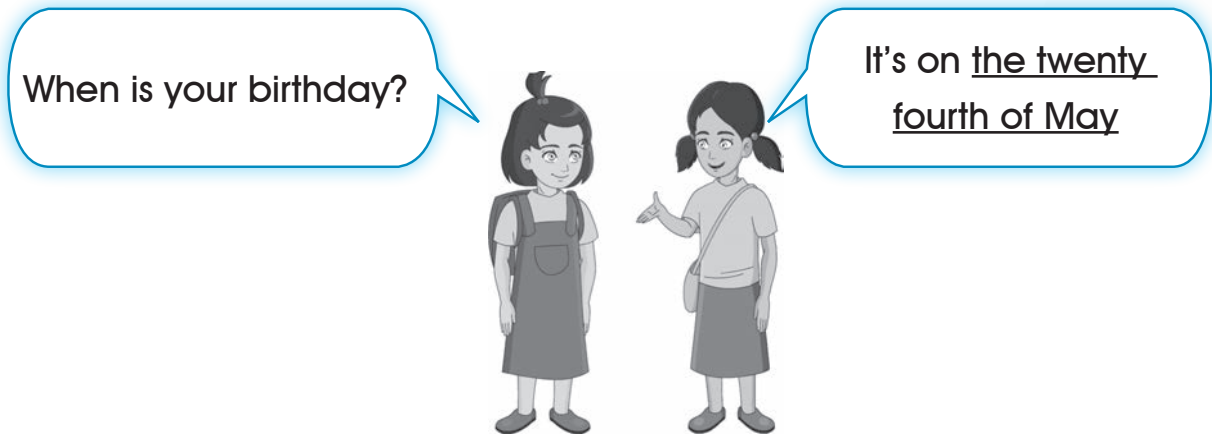

6. Listen and write the names.

1. came first.
2. was the second.
3. was number three.
4. came fourth.

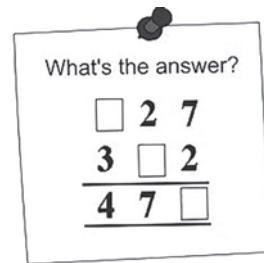

7. How many circles / triangles / rectangles are there?

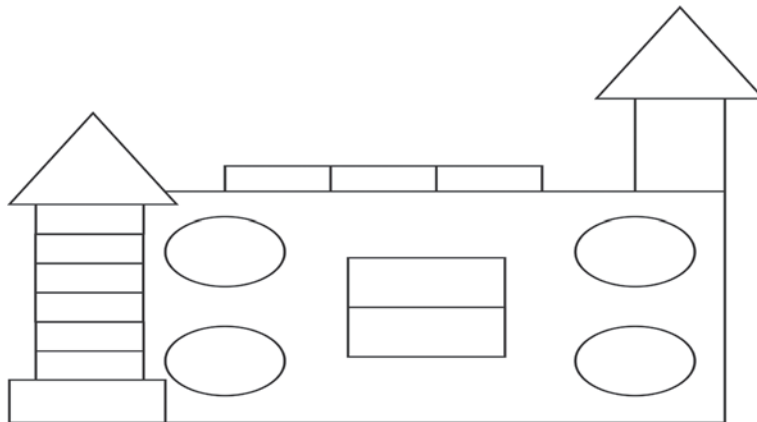

8. Match.

first	3rd
second	6th
third	2nd
fourth	5th
fifth	1st
sixth	4th

9. Fill in the spaces with the correct word.

eleventh third thirty first fifth twenty three

1. Today is the December.



2. Timmy wasn't the winner. He came

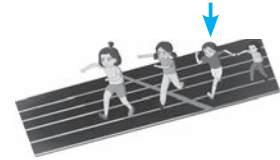

3. There are students in my class.



4. November is the month in the year.



5. My sister's birthday is on theof May.

5

10. Look and complete with the correct words.

1. There are pounds in my pocket.



2. I used to know how much money I have.



3. I said, 2000 ...1000 500.... 200 = 3700



4. I bought a book for six hundred pounds, so I used to know the difference.



5. 3700 – 600 3100.



11. Look and write what Lily has to do.

Lily's List

1st. Help mum.
 2nd. do maths homework.
 3rd. visit grandma.
 4th. buy a present for Tina.

First, she has to help her mum.

-
-
-
-

18

Technology

1. Read the text and do the tasks below.

A break from technology

1.! We are always sitting in front of a screen sending and receiving phone calls, text messages or emails. We live with the mobile and its apps, photos, and videos, as well as the Internet. We play games, listen to music, use GPS, and much more.



We need a break from technology. Every weekend, 2. and the mobile phone and get out in nature with family or friends. We should go for long walks and enjoy the outdoors. 3. and this way we are going to have a balance between science and nature.

a. Write the missing sentences in the spaces.

1. a. It is going to be very relaxing.
2. b. we should switch off the computer.
3. c. We are chained to technology.

b. Match the verb to the noun.

- | | |
|---------------------|---|
| 1. send and receive | a. the computer and the mobile phone |
| 2. chained | b. a balance |
| 3. switch off | c. to technology |
| 4. have | d. phone calls, text messages or emails |

2. Read and match; what are these people going to do?

- | | |
|--|--|
| 1. Hyde is going to the mountains. | a. I am going to buy a new one. |
| 2. My laptop is old and heavy. | b. She's going to take photos with her digital camera. |
| 3. Tim is going too fast on his bicycle! | c. The battery's going to run out. |
| 4. The sky is getting darker and darker. | d. He is going to fall! |
| 5. I didn't charge my phone. | e. It's going to rain. |

3. Listen and circle the words with the sound /u:/.

you- run- few- school- cook- pool- bus- new- music- door

4. Choose one of the technologies below or think of a technical invention that you have had. Then practice a similar conversation. The box can help you.

digital camera / the Internet / TV / laptop / robot / WiFi / ebook / phone / smartwatch / transport / mobile phone

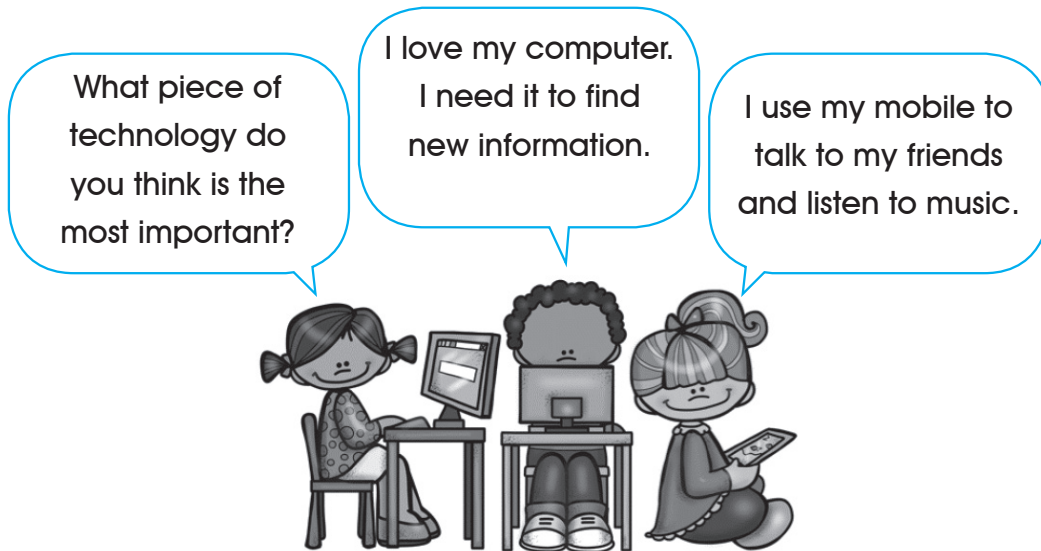

5. a. Listen and match the dialogue to the picture.



a.



b.

b. Listen again and write true (T) or false (F).

1. In the future, they will have robot nurses.
2. The robots will invent new ways of treating the patients.
3. The robots will treat the patients at home.
4. The camera pill will fix the problems from inside the body.
5. People will never get sick in the future.

6. Read and write the correct form of the verb use (going to/ will).

- 1. We believe we..... (travel) to the moon on holiday one day.
- 2. He is running too fast. He (fall).
- 3. I think future transport (not/use) fuel to move.
- 4. I'm sure smartphones (be) able to check our health.
- 5. It's raining. We (not/ swim).

7. Write three predictions about the future of technology.

- a.
- b.
- c.

8. Read this advertisement and write a similar one.

Have you tried the smart watch yet?
This watch is going to change your life.
It is going to give you the time and date for different cities. You are going to use it to answer calls, translate a speech into five different languages, and also play games. You are going to enjoy your time with Future smartwatch.



.....

.....

.....

.....

.....

.....

19

Holidays

1. Read the text and do the tasks below.



Next summer, we are going to camp in one of the most amazing campsites in my country. It's in a forest near a lake. I like the direct contact with nature and that is the best part about camping. We can do many outdoor activities like boating, hiking

and fishing. I'm going to go on a night walk with my parents this year too. Another good thing about camping is that we can play with other children all day. We can swim and ride bikes. At night, we're going to sit around fire, play music and sing. My dad says we aren't going to take a tent or any equipment for camping, because the site has everything we need. However, I'll take my camera and my guitar. I'm so excited.

a. Complete the table.

Andy is going to	camp in	do...
Andy will	take ...	play ...

b. Choose a, b or c.

- Andy is going to have a holiday.
 - sightseeing
 - camping
 - backpacking
- In this holiday he is going to do activities.
 - outdoor
 - indoor
 - dangerous
- Children can go together.
 - climbing
 - diving
 - swimming
- Andy's family aren't going to take a
 - tent
 - guitar
 - camera

2. Complete the activity words.



c _ i m _ i _ _



_ i _ _ n g



m _ _ n _ a _ n b _ k i _ g



c _ m e _ r _ d i n _

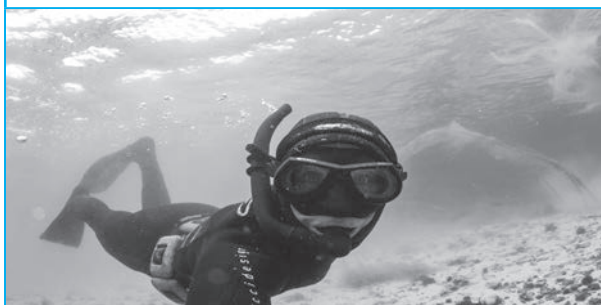

s n _ r k _ _ _ i n g



_ i _ w _ r i _ _

3. Listen and choose.

- a. (time - Tim) b. (fine - Fin)
- a. (kite - kit) b. (bite - bit)

4.  Listen to Allan's plan then choose (a) or (b).

1. The journey name is: a) Across The Sea b) Across The Desert
2. The place is: a) Palmyra b) Lattakia
3. The date is on: a) 30th August b) 13th August
4. They'll see: a) the Island b) the statue of Zenobia
5. They'll go: a) snorkelling b) sand surfing

5. Talk to your friend about your plan for the week.



On Monday, I'm going to play volleyball.

- * play volleyball.
- * meet my friends.
- * visit the museum.
- * go on a picnic.
- * go on a tour.

6. Make sentences in the future, use will.



It's cold

I'll wear a jacket. (wear/ jacket)



I'm hungry

_____ . (eat/ sandwich)



I'm tired

_____ (not go out)



I don't feel well

_____ . (stay/ home)

20

The Solar System

1. Read the text and do the tasks below.

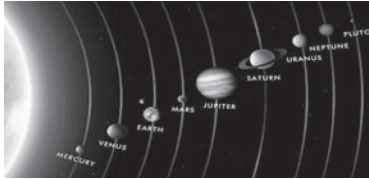

The solar system consists of the Sun and the nine planets. The Sun is not a planet. It's a star. It's in the center of the solar system. All planets orbit the Sun. The Earth takes 365 days to go round the sun; this is how we have the four seasons. Some planets take less or more days than the others. Mercury takes less days than the Earth because it's the closest to the Sun. The Earth also rotates around itself. It takes 24 hours to have a full round. This is why we have day and night. When it is day at one part of the Earth, it's night at the other part.

a. Write true (T) or false (F).

1. The Sun is a planet.
2. All planets go round the Sun.
3. The Earth takes 365 days to go round Mars.
4. There are four seasons on Venus.

b. Choose a, b or c.

1. The Sun and the nine planets are called the system.
a. lunar b. geographic c. solar
2. The Sun is in the.....of the solar system.
a. east b. west c. middle
3.takes the least days to orbit the Sun.
a. Mercury b. Mars c. Venus
4. The Earth takes twenty-four to make a full round.
a. days b. months c. hours
5. When it's night at one part of the Earth, it'sat the other part.
a. day b. spring c. dark

2. Read and match.

1. It's the farthest.	a. a spaceship
2. We live on this planet.	b. the Sun
3. We travel to space on it.	c. the Earth
4. It's a star.	d. the moon
5. It goes round the Earth.	e. Neptune

3. Reorder the planets from the farthest to the nearest to the sun.

Earth / Saturn / Mercury / Uranus / Neptune / Jupiter / Venus / Mars

1.
2.
3.
4.
5.
6.
7.
8.
The Sun

4. Listen and classify the words.

3	ʃ

5. Ask and answer.

- | | |
|---------------------------------|----------------------------------|
| 1. What is the third planet? | - The third planet is the Earth. |
| 2. What is the fourth planet? | - |
| 3. Which is the hottest planet? | - The hottest planet is Venus. |
| 4.? | - The farthest planet is Pluto. |
| 5.? | - |

6.  Listen and underline the correct word.

1. Saturn is a giant (liquid / gas) planet. It is mostly made up of (hydrogen / oxygen) and helium.
2. Saturn is about (760 / 670) times greater than the Earth.
3. It is the (second / third) largest planet in the solar system.
4. You can see the most beautiful rings of Saturn if you fly on a (plane / spaceship).

7. Fill in the spaces with the correct form of the adjectives.

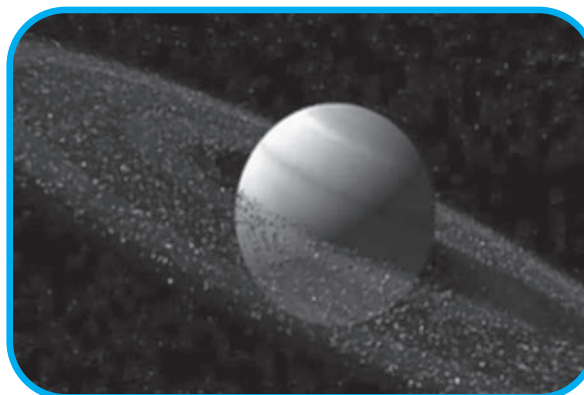

1. The moon is (small) than the Earth.
2. The Earth is (large) than Mercury.
3. Saturn is the (pretty) one.
4. Life on Earth is (wonderful) than life on Venus.

8. Correct the mistakes.

1. Jupiter is the larger planet.

.....

2. Mercury is the close planet to the Sun.

.....

3. Pluto is farthest than Neptune.

.....

4. Venus is the hottest planet.

.....

9. Write five sentences comparing between three planets.

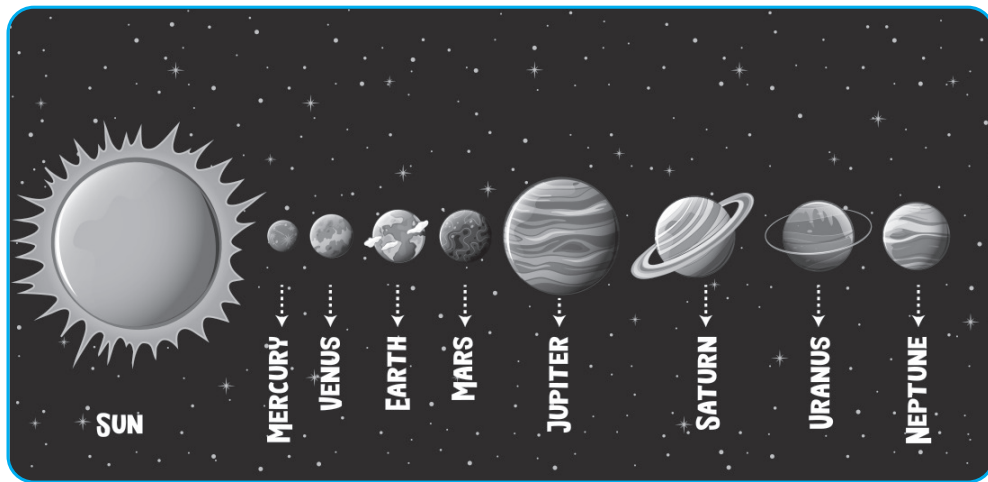

1. Mercury is nearer to the Sun than Venus and Earth.

2.

3.

4.

5.

Revision 4

1. Look at the picture then complete the sentences with the past continuous of the verbs in the box.

sleep - listen - do - watch - decorate - not play

Yesterday afternoon....

1. Mike his homework.
2. John the guitar, he to music.
3. Mr and Mrs Smith a film.
4. Maria a cake when the cat jumped on the table.
5. Ben on the sofa.

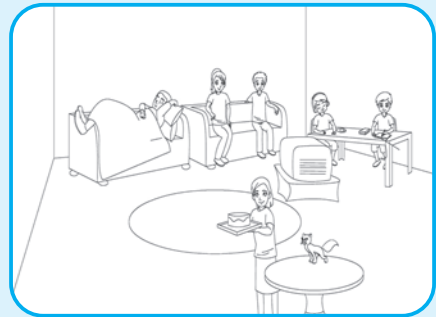

2. Circle the odd word.

1. celebrate - balloons - decorate - WIFI - cake
2. minus - climb - equal - plus - divide
3. zip wiring - hiking - picnic - solar - snorkeling
4. invitation - laptop - e-book - robot - digital
5. Saturn - Mars - plant - Jupiter - Earth

3. Choose either will or be going to.

1. A: Have you got any plans for today's evening?
B: Yes, I (am going to / will) visit my grandfather.
2. A: I am thirsty!
B: I (am going to / will) get you some water.
3. A: What would you like? Coffee or tea?
B: I (am going to / will) have tea, please!
4. A: Why does she want so many oranges?
B: She (is going to / will) make orange juice.
5. A: What did the weather forecast say about the weather?
B: It (is going to / will) be hot and sunny tomorrow.

4. Write the ordinal number.

1. Yesterday was of May.

6

2. The Earth is planet.

3

3. I was born on of June.

15

4. My sister is in grade.

4

5. We live on floor.

9

5. Correct the mistakes.

1. Jupiter is the big planet.

.....

2. Zip wiring is dangerous than hiking.

.....

3. Travelling is going to be fast than now.

.....

4. The cake was the more delicious food in the party.

.....

5. This rectangle is bigger that triangle.

.....

6. Write the missing word.

1. he was riding his bike, he fell off it.

2. She is smart. I think she be a professor.

3. We going to have a sightseeing holiday.

4. My birthday is when you divide forty-six two.